

Power Control ASsys ACsys ULTRALIFT

CE FEM 1.001 - A4
EN 14439 - C25 - D25

Torre/Reazioni – Masts/Reactions – Mat/Réactions – Maste/Eckdrücke – Măstil/Reacciones – Tramo/Reacções

SK1700 FEM

○ Hg=Ht-1 m
 □ Hg=Ht-1.8 m

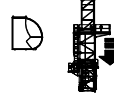
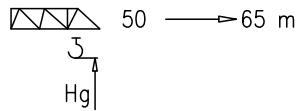

6	BCF052	2/4
5	BPF117	4/4
4	BPF039	4/4
3	ST117	2/2
2	BAF117	4/2
1	ST039	2/2

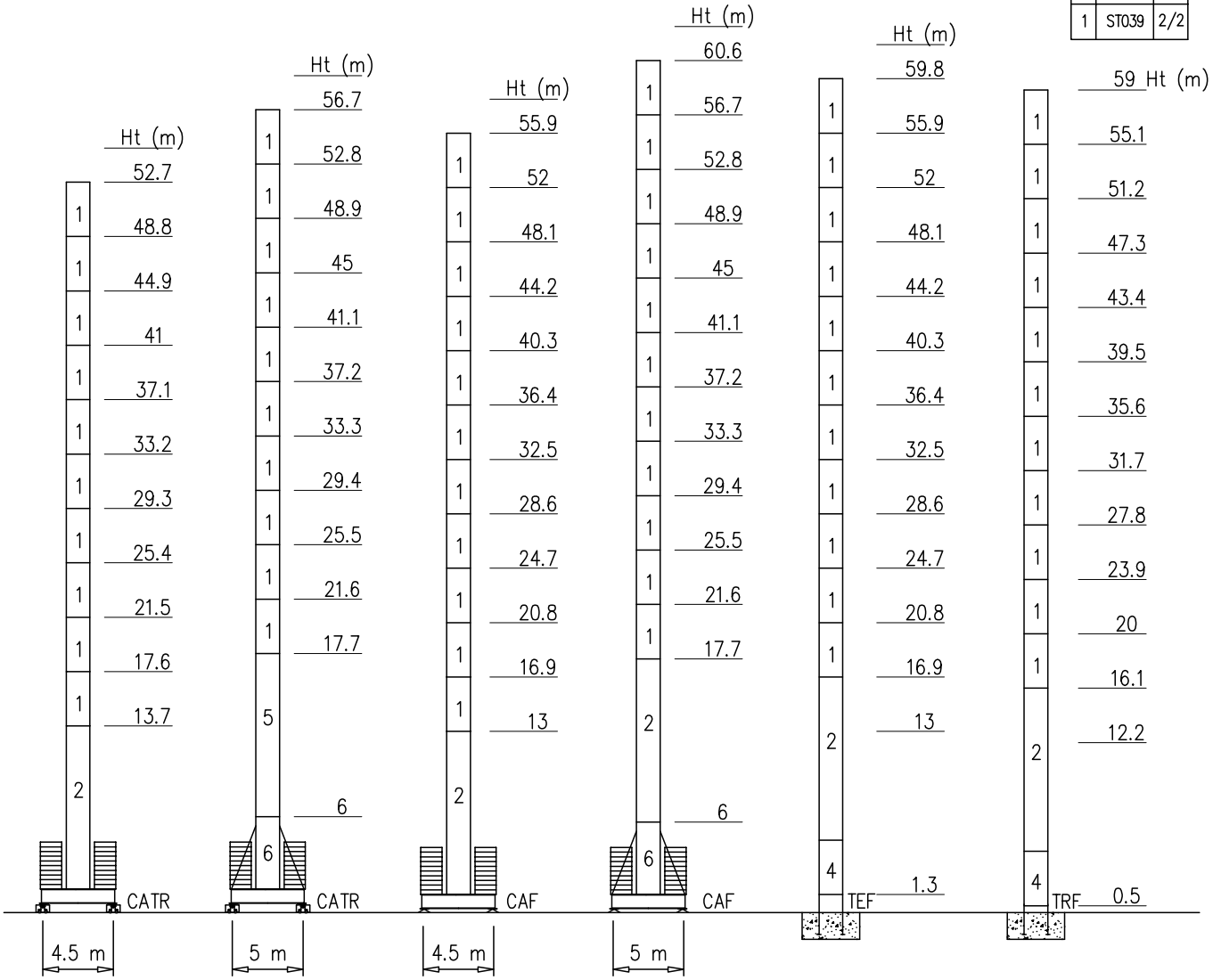

Peso zavorra – Ballast weight – Poids du lest – Ballastgewicht – Peso de lastre

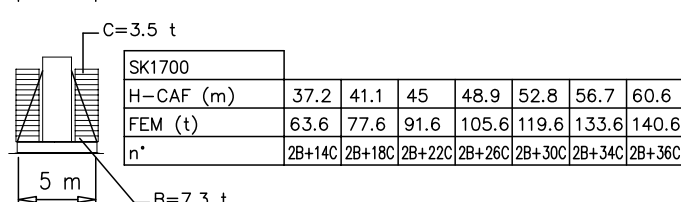
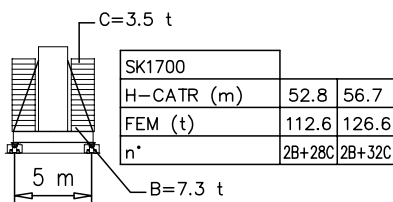
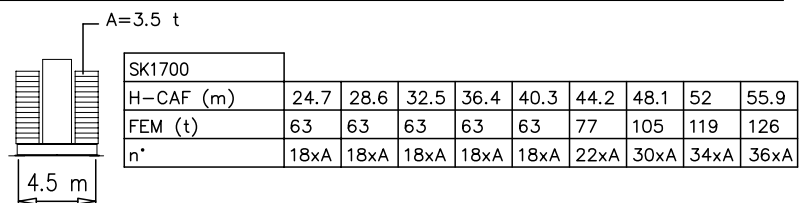
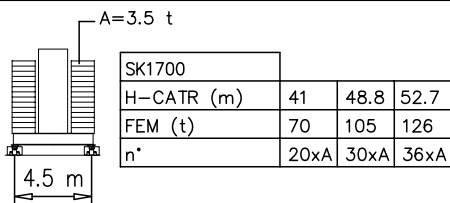

Torre/Reazioni – Masts/Reactions – Mat/Réactions – Maste/Eckdrücke – Mástil/Reacciones – Tramo/Reacções

SK1700 EN14439-C25

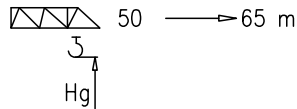

- Hg=Ht-1 m
- Hg=Ht-1.8 m

6	BCF052	2/4
5	BPF117	4/4
4	BPF039	4/4
3	ST117	2/2
2	BAF117	4/2
1	ST039	2/2

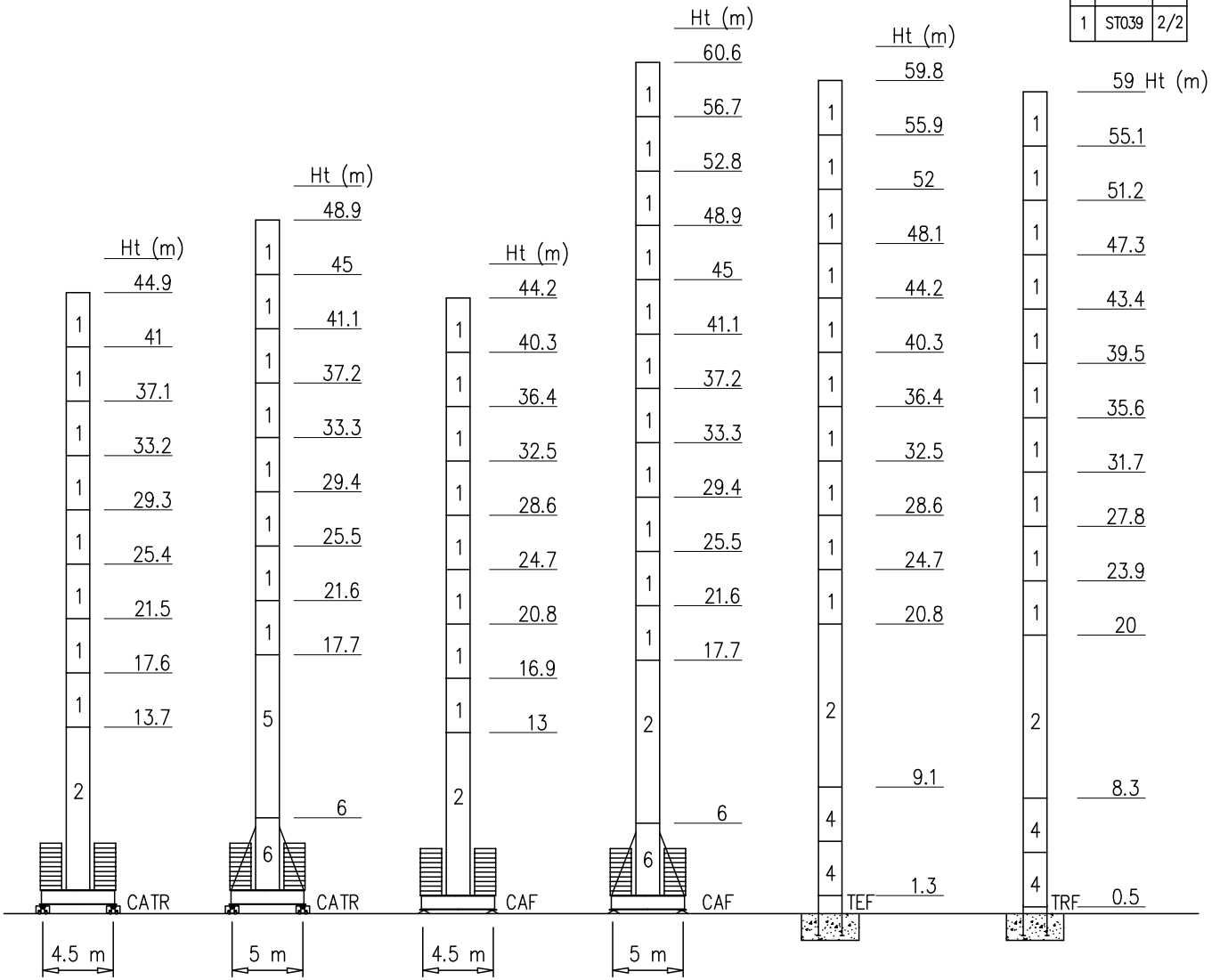

Peso zavorra – Ballast weight – Poids du lest – Ballastgewicht – Peso de lastre

A=3.5 t

SK1700	
H-CATR (m)	41 48.8 52.7
(t)	70 105 126
n*	20xA 30xA 36xA

A=3.5 t

SK1700	
H-CAF (m)	24.7 28.6 32.5 36.4 40.3 44.2
(t)	77 77 91 105 119 126
n*	22xA 22xA 26xA 30xA 34xA 36xA

C=3.5 t

SK1700	
H-CATR (m)	45 48.9 52.8 56.7
(t)	112.6 126.6 147.6 154.6
n*	2B+28C 2B+32C 2B+38C 2B+40C

C=3.5 t

SK1700	
H-CAF (m)	33.3 37.2 41.1 45 48.9 52.8 56.7 60.6
(t)	63.6 77.6 91.6 105.6 119.6 133.6 147.6 154.6
n*	2B+14C 2B+18C 2B+22C 2B+26C 2B+30C 2B+34C 2B+38C 2B+40C

Torre/Reazioni – Masts/Reactions – Mat/Réactions – Maste/Eckdrücke – Mástil/Reacciones – Tramo/Reacções

SK1700 EN14439-D25

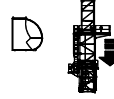
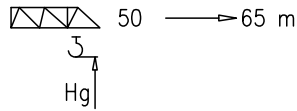

6	BCF052	2/4
5	BPF117	4/4
4	BPF039	4/4
3	ST117	2/2
2	BAF117	4/2
1	ST039	2/2

- Hg=Ht-1 m
- Hg=Ht-1.8 m

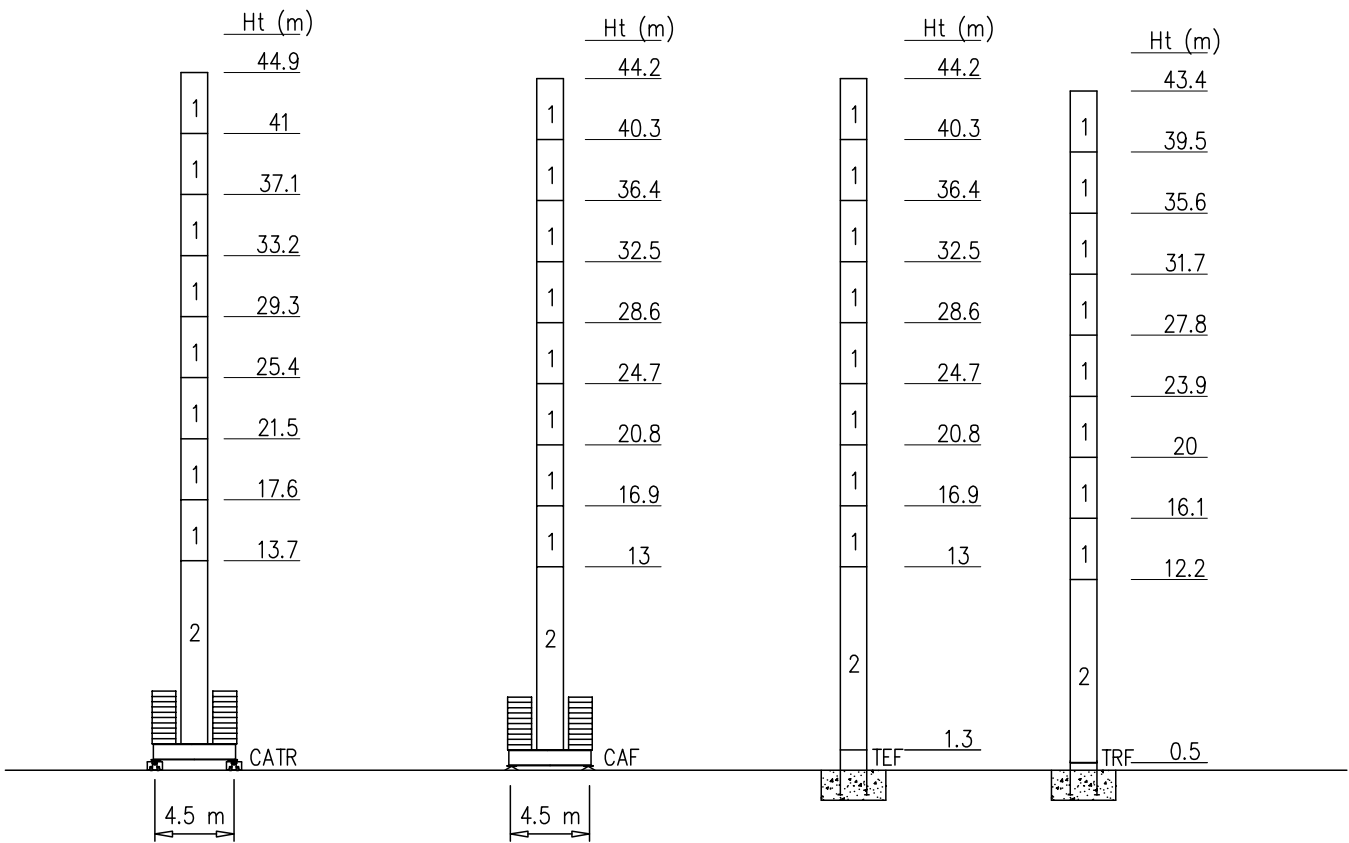

Peso zavorra – Ballast weight – Poids du lest – Ballastgewicht – Peso de lastre

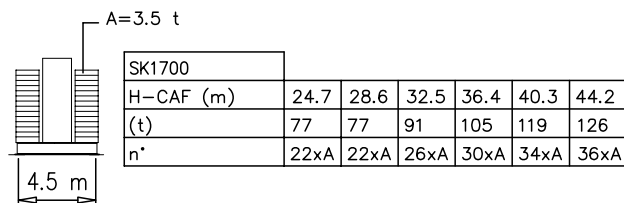
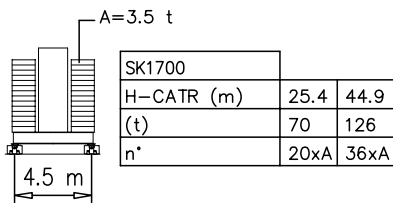

Torre/Reazioni – Masts/Reactions – Mat/Réactions – Maste/Eckdrücke – Mástil/Reacciones – Tramo/Reacções

SN2050 FEM

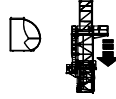
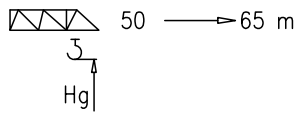

○ Hg=Ht-1 m
 □ Hg=Ht-1.8 m

14	BCF052	2/4 M45
13	BAF052	2/4 M42
12	BPF117	4/4 M45-45
11	BNF117	4/4 M45-42
10	BOF117	4/4
9	BOF039	4/4
8	B0039	2/2
7	STR039	2/2
6	SBR117	4/2
5	SBR039	4/2
4	SB117	4/2
3	SB039	4/2
2	ST117	2/2
1	ST039	2/2

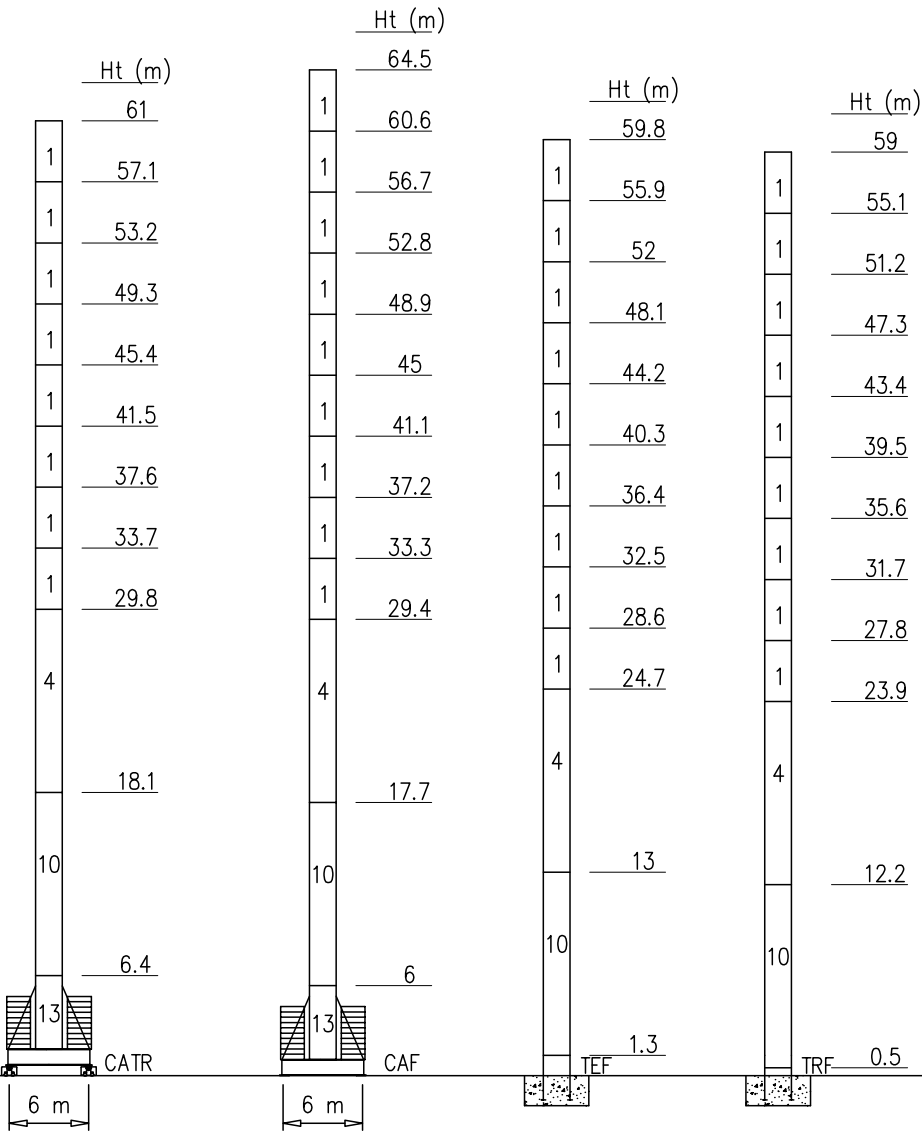

Peso zavorra – Ballast weight – Poids du lest – Ballastgewicht – Peso de lastre

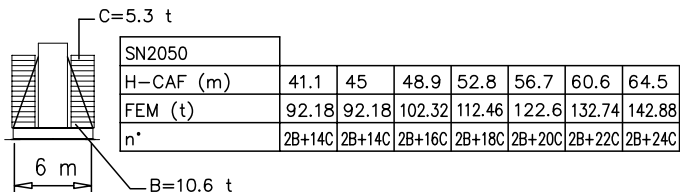
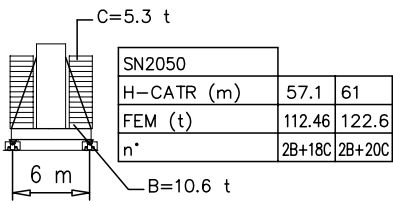

Torre/Reazioni – Masts/Reactions – Mat/Réactions – Maste/Eckdrücke – Mástil/Reacciones – Tramo/Reacções

SN2050 EN14439-C25

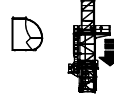
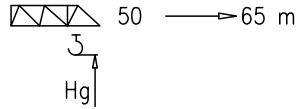

- Hg=Ht-1 m
- Hg=Ht-1.8 m

14	BCF052	2/4 M45
13	BAF052	2/4 M42
12	BPF117	4/4 M45-45
11	BNF117	4/4 M45-42
10	BOF117	4/4
9	BOF039	4/4
8	BO039	2/2
7	STR039	2/2
6	SBR117	4/2
5	SBR039	4/2
4	SB117	4/2
3	SB039	4/2
2	ST117	2/2
1	ST039	2/2

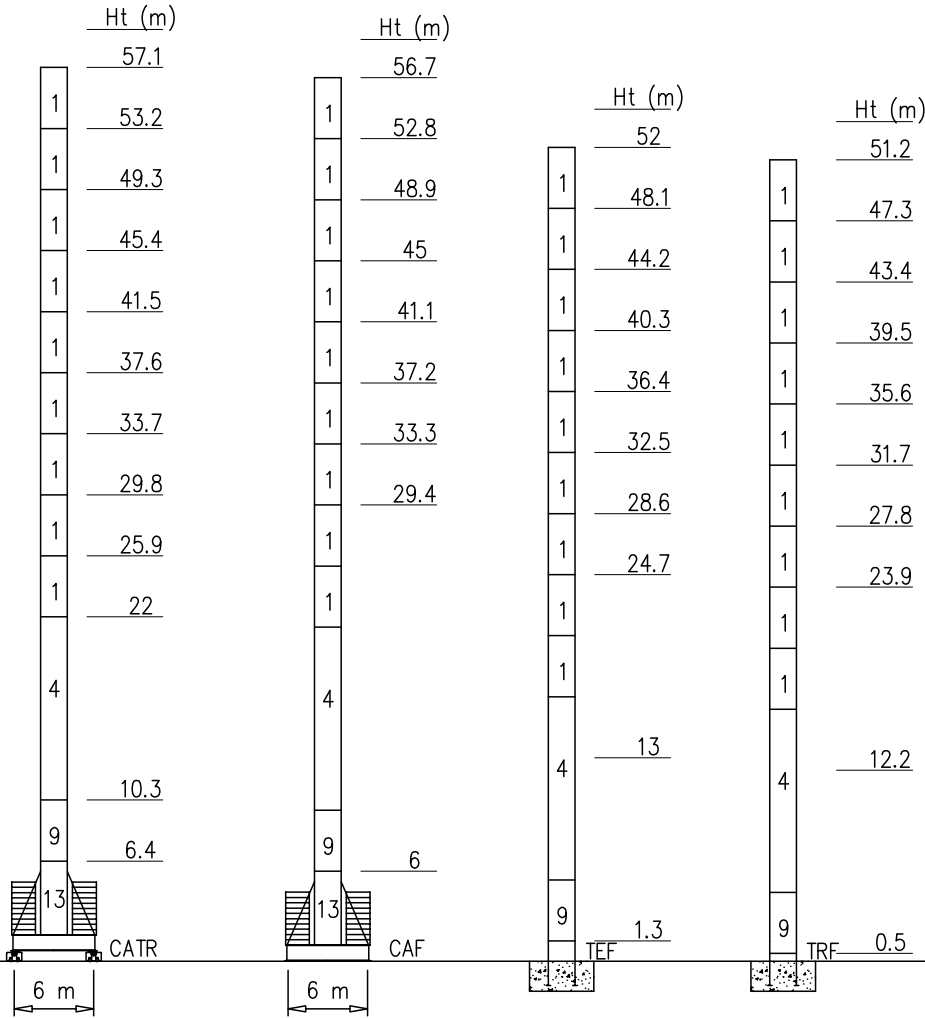

Peso zavorra – Ballast weight – Poids du lest – Ballastgewicht – Peso de lastre

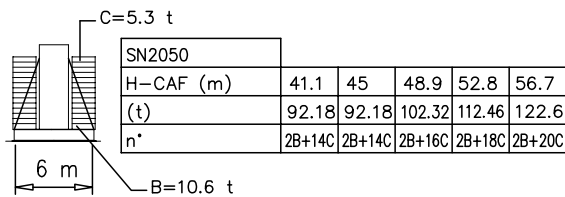
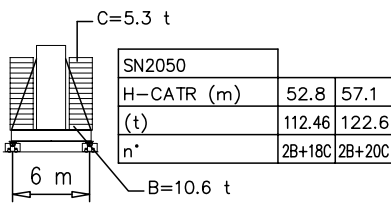

Torre/Reazioni – Masts/Reactions – Mat/Réactions – Maste/Eckdrücke – Mástil/Reacciones – Tramo/Reacções

SN2050 EN14439-D25

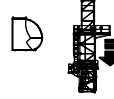
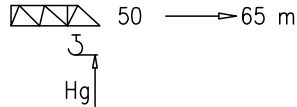

- Hg=Ht-1 m
- Hg=Ht-1.8 m

14	BCF052	2/4 M45
13	BAF052	2/4 M42
12	BPF117	4/4 M45-45
11	BNF117	4/4 M45-42
10	BOF117	4/4
9	BOF039	4/4
8	BO039	2/2
7	STR039	2/2
6	SBR117	4/2
5	SBR039	4/2
4	SB117	4/2
3	SB039	4/2
2	ST117	2/2
1	ST039	2/2

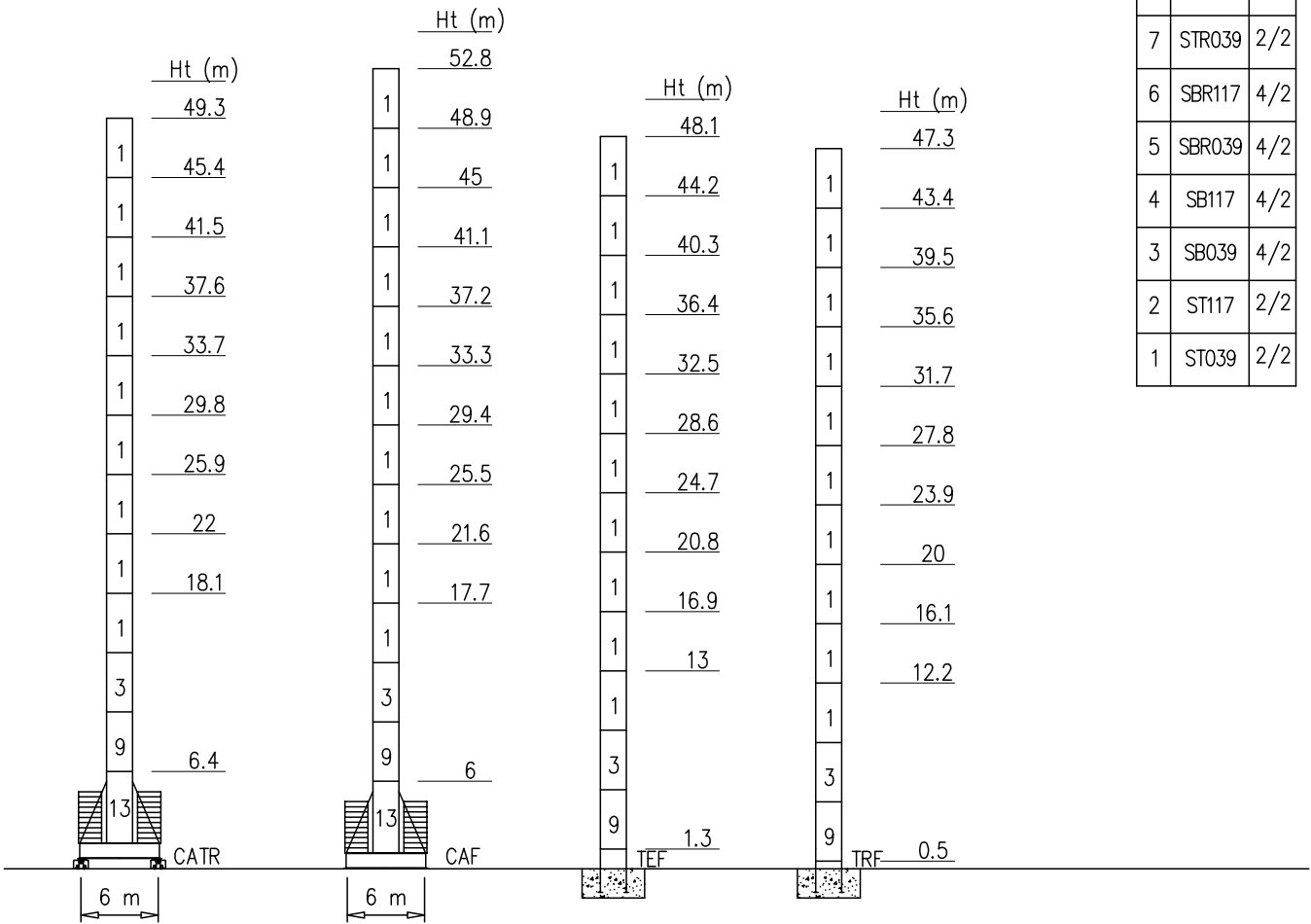

Peso zavorra – Ballast weight – Poids du lest – Ballastgewicht – Peso de lastre

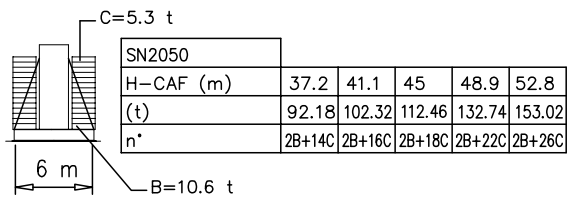
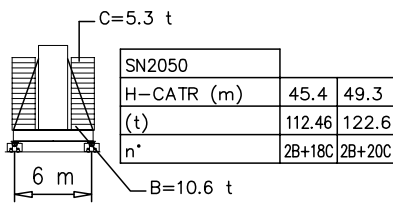

Curve di carico – Courbes de charges – Load diagrams – LastKurven – Curvas de cargas

Pmax 3000 kg

	25560 kg	65 m	3.5				32.3	34	36	38	40	42	44	46	48	50	52	54	56	58	60	62	65	m
			3000				3000	2950	2750	2570	2410	2260	2130	2010	1900	1800	1710	1620	1540	1470	1400	1350	1000	kg
	25560 kg	63 m	3.5						36.1	38	40	42	44	46	48	50	52	54	56	58	60	63	m	
			3000						3000	2570	2410	2260	2130	2010	1900	1800	1710	1620	1540	1470	1400	1300	kg	
	25560 kg	60 m	3.5							41.9	42	44	46	48	50	52	54	56	58	60	m			
			3000							3000	2700	2550	2410	2280	2170	2060	1960	1870	1840	1800	kg			
	25560 kg	56 m	3.5							43.4	44	46	48	50	52	54	56	m						
			3000							3000	2870	2670	2540	2400	2300	2130	2100	kg						
	22720 kg	50 m	3.5							45	46	48	50	m										
			3000							3000	2810	2670	2600	kg										

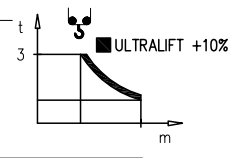

Pmax 6000/3000 kg

	25560 kg	65 m	3.5	18	22	26	30	32	34	36	38	40	42	44	46	48	50	52	54	56	58	60	62	65	m
			6000	6000	4900	4050	3420	3170	2950	2750	2570	2410	2260	2130	2010	1900	1800	1710	1620	1540	1470	1400	1350	1000	kg
	25560 kg	63 m	3.5	18	22	26	30	32	34	36	38	40	42	44	46	48	50	52	54	56	58	60	63	m	
			6000	6000	4900	4050	3420	3170	2950	2750	2570	2410	2260	2130	2010	1900	1800	1710	1620	1540	1470	1400	1300	kg	
	25560 kg	60 m	3.5	20	22	26	30	32	34	36	38	40	42	44	46	48	50	52	54	56	58	60	m		
			6000	6000	5720	4750	4030	3740	3480	3250	3050	2860	2700	2550	2410	2280	2170	2060	1960	1870	1780	1700	kg		
	25560 kg	56 m	3.5		22	26	30	32	34	36	38	40	42	44	46	48	50	52	54	56	m				
			6000		6000	5640	4810	4470	4000	3730	3510	3300	3030	2870	2670	2540	2400	2300	2130	2000	kg				
	22720 kg	50 m	3.5		26	30	32	34	36	38	40	42	44	46	48	50	m								
			6000		6000	5170	4810	4500	4000	3680	3470	3220	3050	2810	2670	2500	kg								

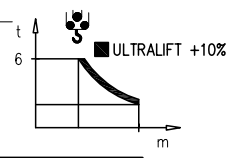





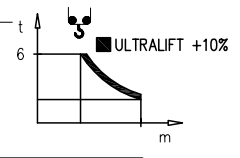



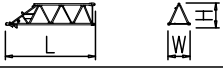

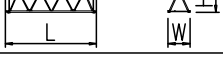
Pmax 6000 kg

	25560 kg	65 m	3.5	18.9	22	26	30	32	34	36	38	40	42	44	46	48	50	52	54	56	58	60	62	65	m
			6000	6000	4900	4050	3420	3170	2950	2750	2570	2410	2260	2130	2010	1900	1800	1710	1620	1540	1470	1400	1350	1000	kg
	25560 kg	63 m	3.5	21	22	26	30	32	34	36	38	40	42	44	46	48	50	52	54	56	58	60	63	m	
			6000	6000	4900	4050	3420	3170	2950	2750	2570	2410	2260	2130	2010	1900	1800	1710	1620	1540	1470	1400	1300	kg	
	25560 kg	60 m	3.5	23.4	26	30	32	34	36	38	40	42	44	46	48	50	52	54	56	58	60	m			
			6000	6000	4750	4030	3740	3480	3250	3050	2860	2700	2550	2410	2280	2170	2060	1960	1870	1840	1800	kg			
	25560 kg	56 m	3.5	24.3	26	30	32	34	36	38	40	42	44	46	48	50	52	54	56	m					
			6000	6000	5640	4810	4470	4000	3730	3510	3300	3030	2870	2670	2540	2400	2300	2130	2000	kg					
	22720 kg	50 m	3.5		25.3	30	32	34	36	38	40	42	44	46	48	50	m								
			6000		6000	5170	4810	4500	4000	3680	3470	3220	3050	2810	2670	2500	kg								

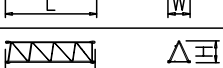

PESI E INGOMBRI – PACKING LIST – LISTE DE COLISAGE – GEWICHT UND ABMESSUNGEN

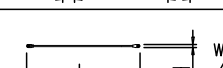
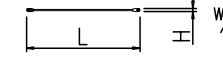
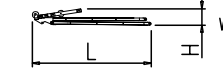
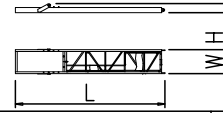
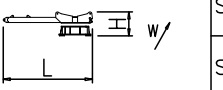
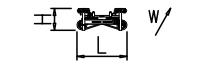
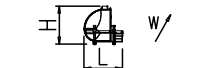
Denominazione Description	Disegno Draw	Pezzi Pieces	Dimensioni-Dimensions (mm)			Peso-Weight (kg)		
			L	W	H	Unit	Total	
Elemento di braccio Jib element Elément de èche Elemento de flecha	n°1 	1	5760	1440	1600	950	–	
	n°2 	1	5820	1400	1470	750	–	
	n°3 	1	5860	1400	1470	810	–	
	n°4 	1	5860	1400	1470	730	–	
	n°5 	1	5860	1400	1470	740	–	
	n°6 	1	5850	1400	1470	700	–	
	n°7 	1	5820	1400	1470	680	–	
	n°8 	1	5820	1400	1470	740	–	
	n°9 	1	5850	1400	1450	520	–	
	n°10 	1	5740	1400	1450	410	–	
	n°11 	1	5770	1400	1450	330	–	
	n°12 	1	4350	1400	1450	320	–	
	Punta 	1	800	1400	1400	170	–	
Tirante completo Complete tie rod Tirant complète Tirante completo		12	6500	200	200	240	3540	
Cuspide Cusp Pointre Cùspide		1	8300	1500	1000	2700	–	
Contorbraccio completo Complete counterjib Contreflèche complète Contraflecha completa		1	9300	1650	600	2000	–	
Gruppo girevole Slewing group Table tournante Grupo giratorio		SK1700	1	5100	1810	1400	6000	–
		SN2050	1	5100	1810	1400	6300	–
Carrello Trolley Chariot Carretilla		1	1900	1620	1000	400	–	
Ballatoio con cabina Access balcony with cabin Porte cabine Balcòn corrido con cabina		1	2500	2150	2450	1000	–	

PESI E INGOMBRI – PACKING LIST – LISTE DE COLISAGE – GEWICHT UND ABMESSUNGEN

Denominazione Description	Disegno Draw	Pezzi Pieces	Dimensioni-Dimensions (mm)			Peso-Weight (kg)		
			L	W	H	Unit	Total	
Blocchi contrappeso Counterweight block Contre-poids Bloques de contrapeso	VX28 	9	1100	280	3700	2840	25600	
Elemento di torre Mast element Elément de mature Elemento de torre	ST039 	SK1700	–	3900	1785	1785	1750	–
	STR039 	SN2050	–	3900	2110	2110	2320	–
	ST052 	SK1700	–	5200	1785	1785	2250	–
	ST117 	SK1700	–	11700	1785	1785	4690	–
		SN2050	–	11700	2110	2110	5790	–
	SB039 	SK1700	–	3900	1785	1785	2100	–
	SB039 	SN2050	–	3900	2110	2110	2710	–
	SB052 	SK1700	–	5200	1785	1785	2600	–
	SB117 	SK1700	–	11700	1785	1785	4830	–
		SN2050	–	11700	2110	2110	7000	–
	BOF039 	SK1700	–	3900	1785	1785	2450	–
	BO039 	SN2050	–	3900	2110	2110	3370	–
BOF052 	SK1700	–	5200	1785	1785	3390	–	
BOF117 BNF117 BPF117 	SK1700	–	11700	1785	1785	6920	–	
	SN2050	–	11700	2110	2110	8180	–	
Elemento di base Base element Mat de base Elemento de base	BAF052 	SK1700	1	5200	2060	2060	3650	–
	BCF052 	SN2050	1	5200	2260	2260	4040	–
Carro di base Base carriage Chassis de base Cruceta de base		4.5x4.5	1	6670	500	1260	3180	3180
		5x5	1	7550	670	780	2300	2300
		6x6	1	8870	670	780	2500	2500
		4.5x4.5	2	3100	500	1260	1400	2800
		5x5	2	3530	420	780	1060	2120
		6x6	2	4320	420	780	1200	2400
Puntoni di base Rafter Jambes de force Cabrios de base		5x5	4	4250	240	300	280	1120
		6x6	4	4560	420	300	420	1680
Elemento a perdere Disposable frame Chassis a perdre Bastidor desechable		SK1700	1	1840	1910	1910	1430	–
		SN2050	1	2600	2260	2260	2030	–
Elemento recuperabile Recoverable frame Chassis récupérable Bastidor recuperable		SK1700	1	1300	2170	2170	1720	–
		SN2050	1	1300	2620	2620	1860	–
Bogie di traslazione Driven bogie Boggie motoriseè Balancin de traslaciòn			4	1160	700	600	700	2800
Blocco zavorra di base Base ballast block Lest de base Bloque de lastre		4.5x4.5	–	4400	1200	290	3500	–
		5x5	2	5300	1000	600	7300	14600
	6x6	2	6400	1200	600	10600	21200	
		5x5	–	4100	1600	300	3500	–
6x6		–	4800	2000	300	5070	–	
Corsoio di montaggio Climbing cage Cage de montage Jaula de montaje		SK1700	1	8300	2600	2500	6000	–
		SN2050	1	8300	2900	2700	6700	–

GRU IN CAVEDIO – TELESCOPAGE SUR DALLES – CLIMBING CRANE – KLETTERKRANE IM GEBAUDE

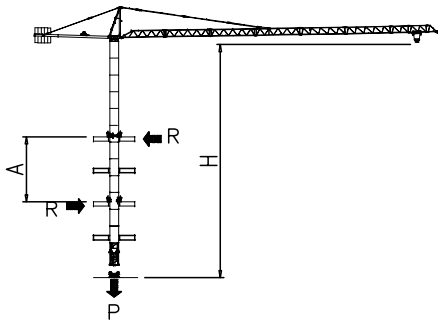

SK1700	H (m)	A (m)
	39	Min 9
Apertura passaggio gru Opening for crane passing 		Max 12

SN2050	H (m)	A (m)
	50.8	Min 9
Apertura passaggio gru Opening for crane passing 		Max 12

SOPRALZO IDRAULICO – TELESCOPABLE – EXTERNAL CLIMBING – KLETTERKRANE

FEM

	SK1700
MAX C	32.5 m
B	19.5 m
A	46.8 m

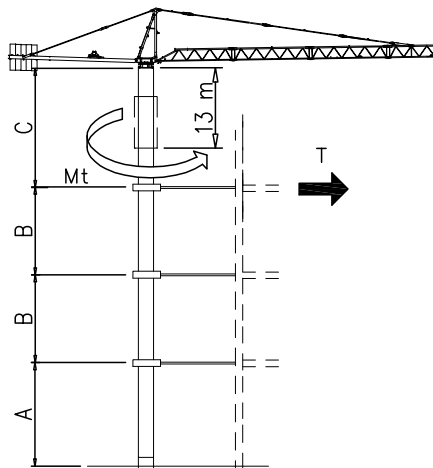

	SN2050
MAX C	36.4 m
B	23.4 m
A	46.8 m

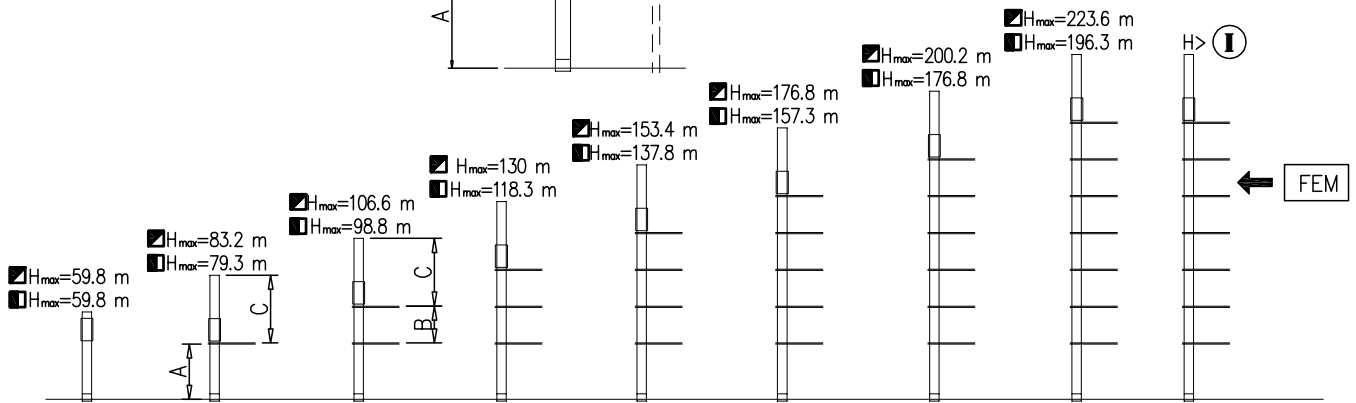

Montaggio – Montage – Erection – Montage – Montaje – Montagem

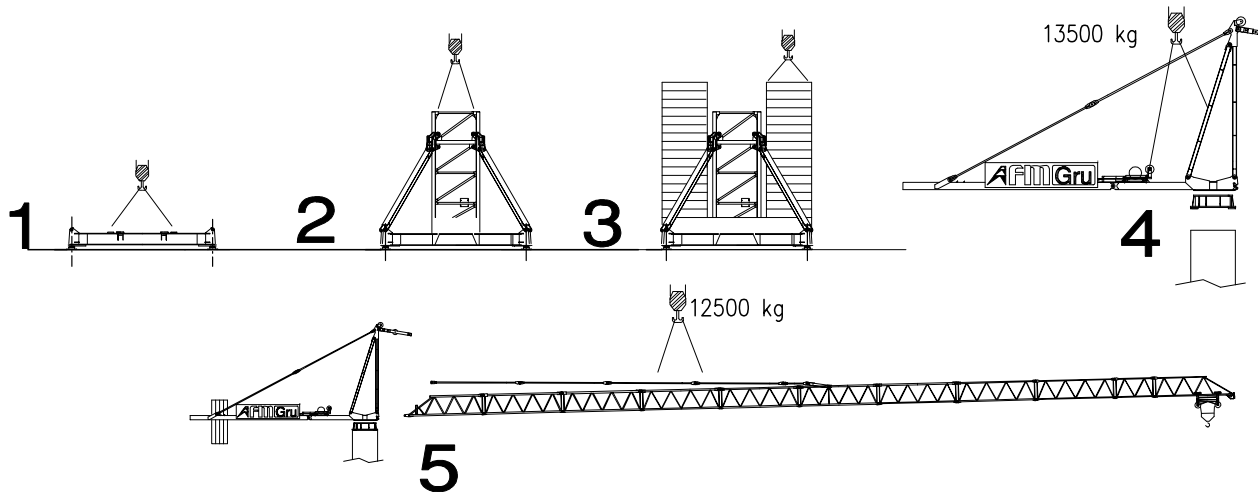

Meccanismi – Mechanisms – Mécanismes – Antriebe – Mecanismos

Sollevamento V25.60 Hoisting Levage Heben Elevaciòn Elevaçao								 	V25.60 18.4 kW 37 kVA 264 m 528 m (L)
	m/min	7	18	28	42	56	65		
	t	3	3	3	2.25	1.5	0.9		
	m/min	3.5	9	14	21	28	32.5		
t	6	6	6	4.5	3	1.8			
Sollevamento V33.90 Hoisting Levage Heben Elevaciòn Elevaçao								 	V33.90 22 kW 47 kVA 380 m 760 m (L)
	m/min	3	18	34	54	70	90		
	t	3	3	3	1.8	1.3	0.5		
	m/min	1.5	9	17	27	35	45		
t	6	6	6	3.6	2.6	1			
Sollevamento V45.60 Hoisting Levage Heben Elevaciòn Elevaçao									V45.60 33 kW 57 kVA 270 m 500 m (L)
	m/min	3	14	30	45	60	72		
	t	6	6	6	3.5	2.4	1.4		

Carrello Trolleying Distribution Katzfahren Distribuciòn Distribuiçao			0 → 85	m/min	3 kW	Potenza elettrica necessaria Puissance électrique nécessaire Necessary electric power Anschlusswert – Potencia
Rotazione Slewing Orientation Schwenken Orientaciòn Rotaçao			0 → 0,9	giri/min tr/min rp/min	4.4 kW @ 1200rpm n° 2 x 2.2 kW	
Traslazione Travelling Translation Kranfahren Traslaciòn Traslaçao			0 → 20	m/min	7.5 kW	

Rete elettrica – Réseau – Mains supply – Netzstrom – Red – Rede electrica	400V – 50 Hz
---	--------------

Rete elettrica – Réseau – Mains supply – Netzstrom – Red – Rede electrica	400V – 50 Hz
---	--------------

FEM 1.001 2000/14/CE	
-------------------------	--